

COMP	INSIDE HEIGHT	INSIDE WIDTH	INSIDE DEPTH	CLEAR OPENING HEIGHT	CLEAR OPENING WIDTH
M1	65.64	20.00	18.25	64.78	18.76
M2	42.50	30.32	18.25	39.48	28.01
M3	40.00	33.94	18.25	39.48	30.51

Note: All dimensions are approximate and subject to change.

# Type 3 LE\_94 / 148

# 94" X 148" Module on Ford E350 138" WB chassis, 72" Headroom

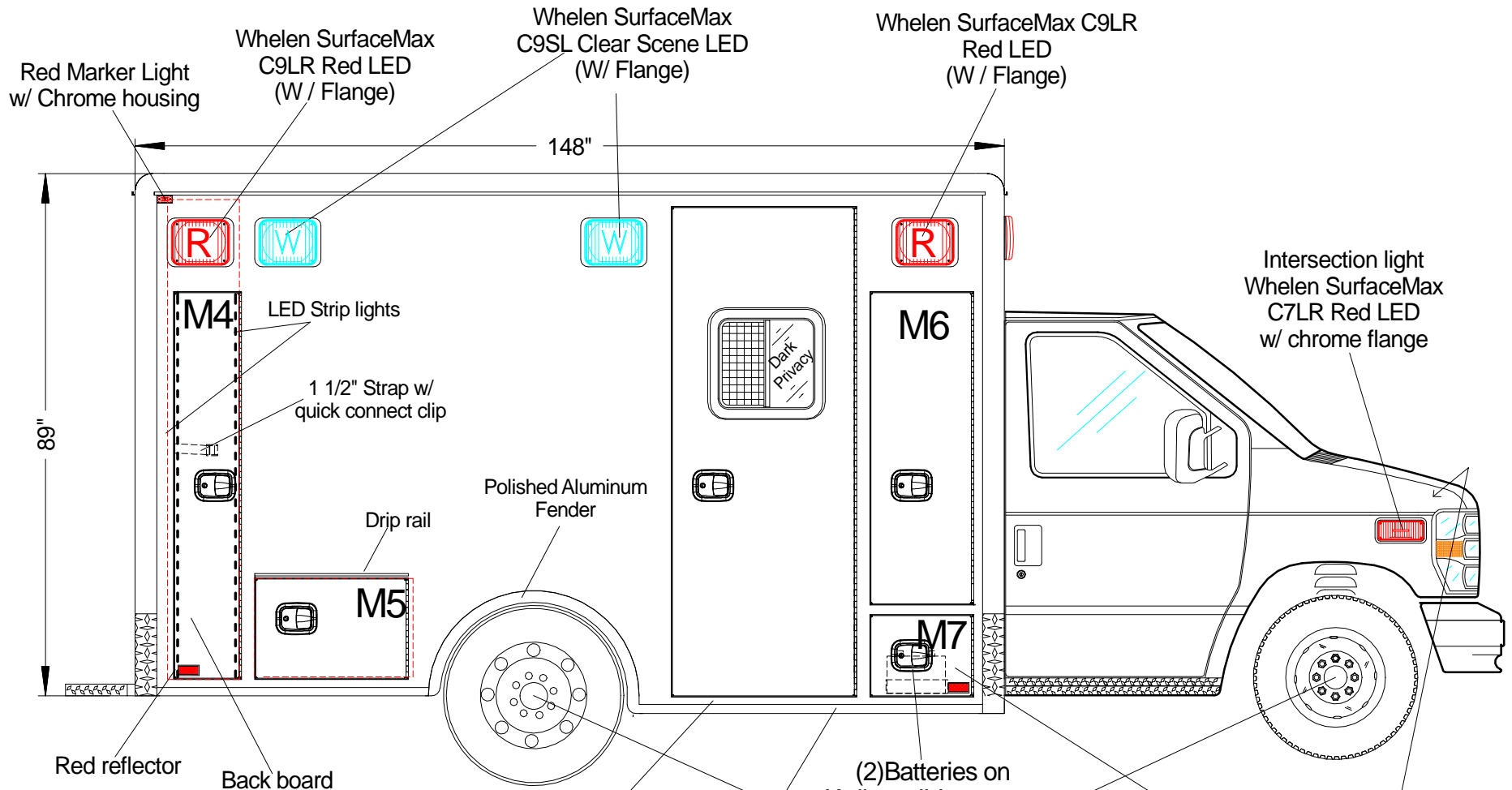

COMP	INSIDE HEIGHT	INSIDE WIDTH	INSIDE DEPTH	CLEAR OPENING HEIGHT	CLEAR OPENING WIDTH
M4	84.98	12.25	18.25	65.64	9.94
M5	19.00	27.14	18.25	19.00	21.50
M6				49.63	16.45
M7	13.07	18.67	18.25	12.51	16.45

Note: All dimensions are approximate and subject to change.

VIEW: Curbside Exterior

Dwn. By: Jorge M.

LE- 2



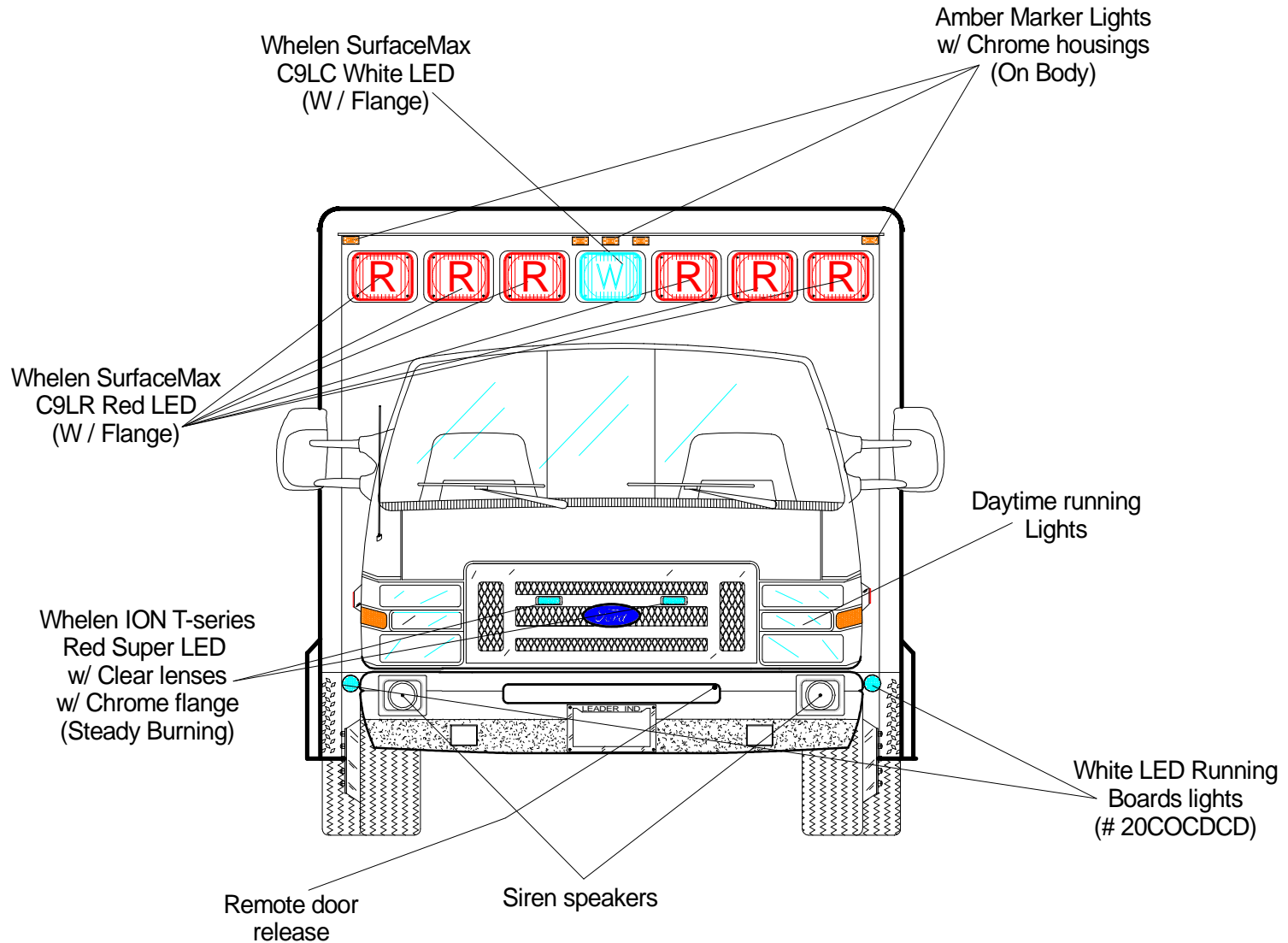

Note: All dimensions are approximate and subject to change.



Type 3 LE 94 / 148

94" X 148" Module on Ford E350 138" WB chassis, 72" Headroom

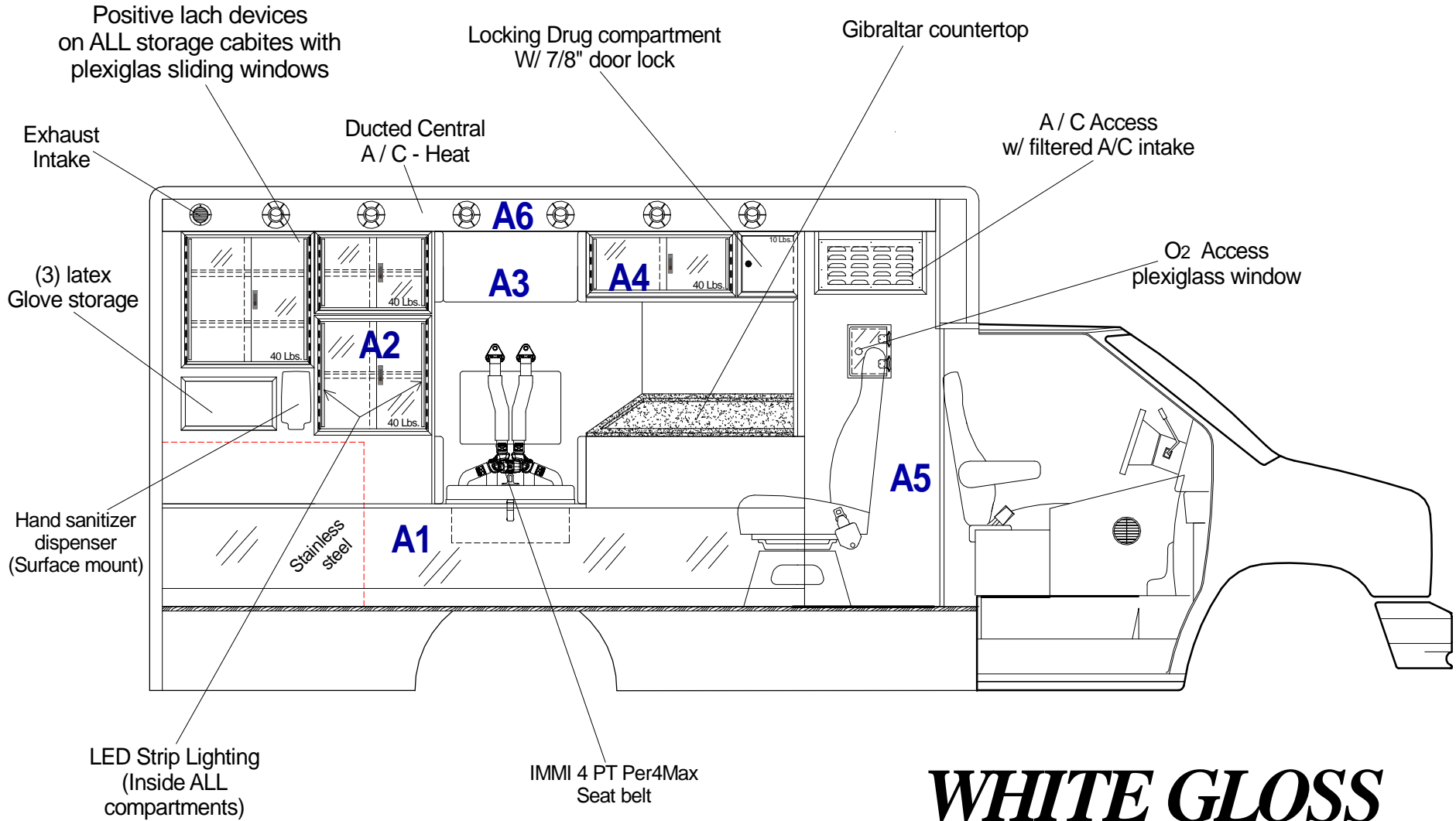

**WHITE GLOSS LAMINATE**

Note: All dimensions are approximate and subject to change.

VIEW: Streetside Interior

Dwn. By: Jorge M.

LE- 5



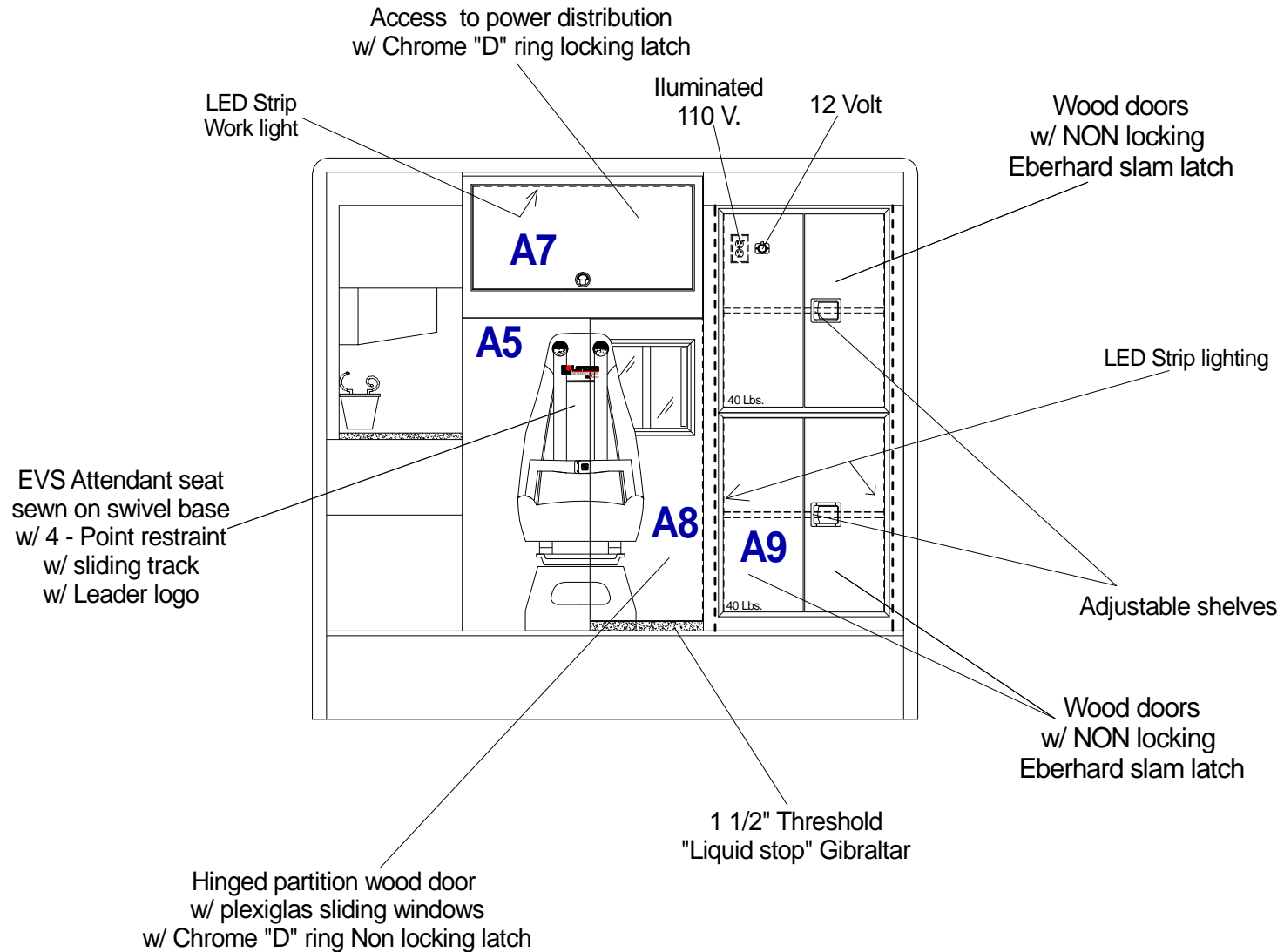

Note: All dimensions are approximate and subject to change.

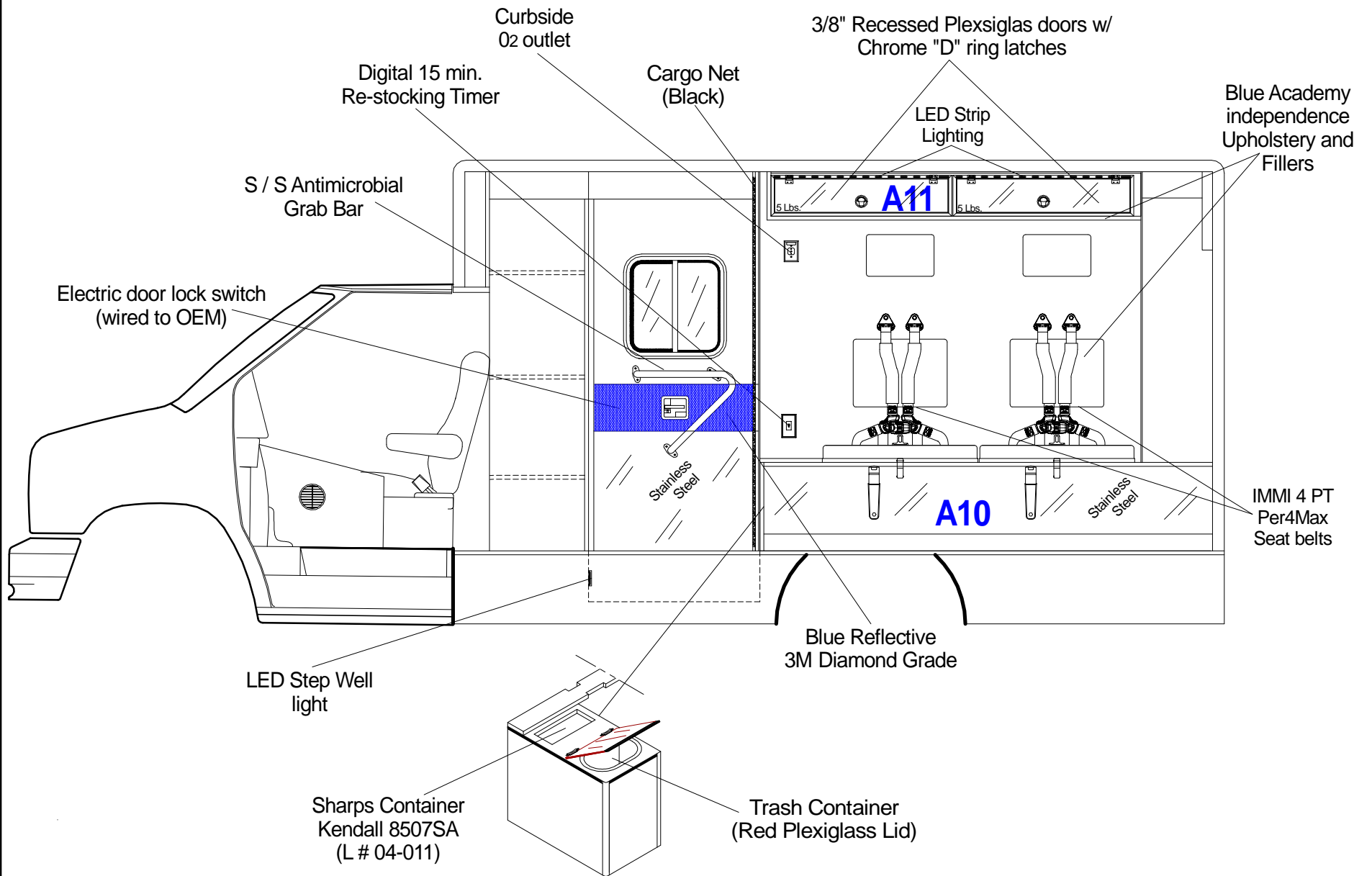

Note: All dimensions are approximate and subject to change.

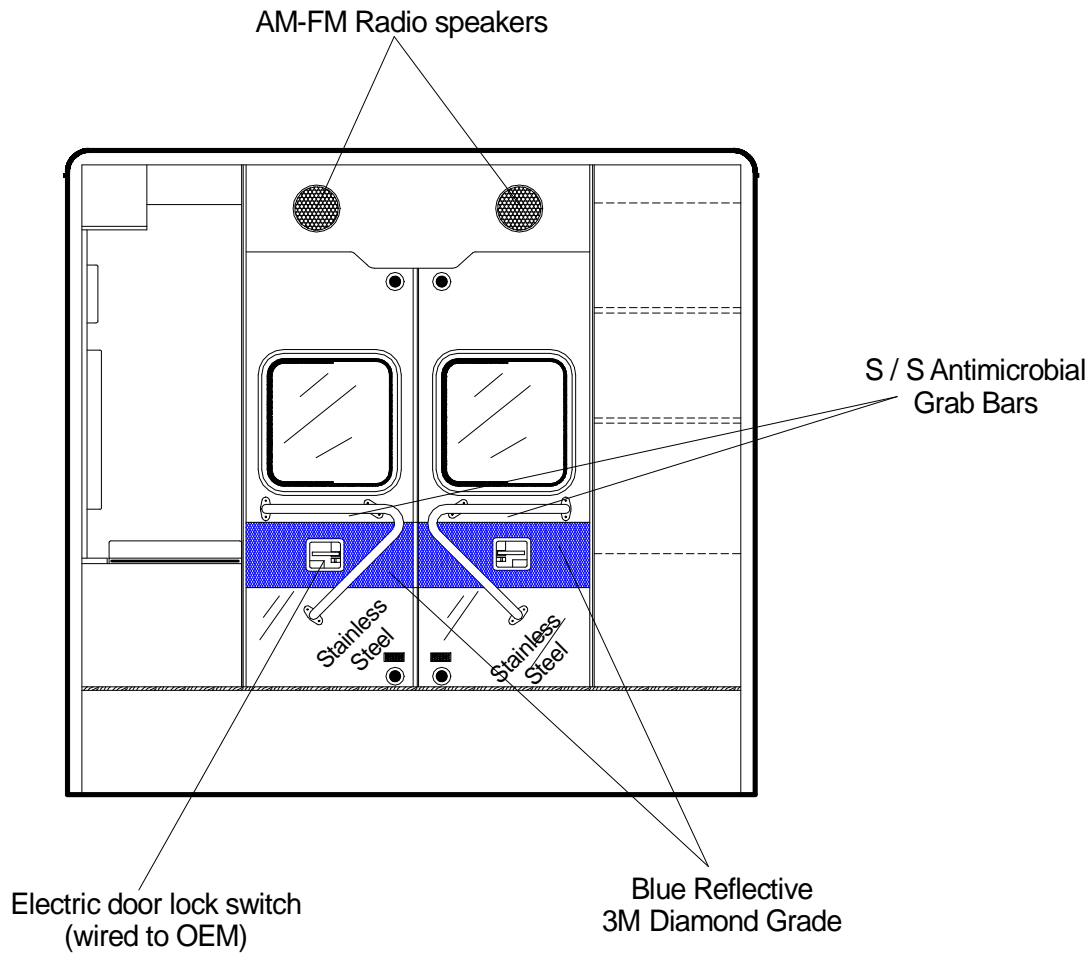

Note: All dimensions are approximate and subject to change.



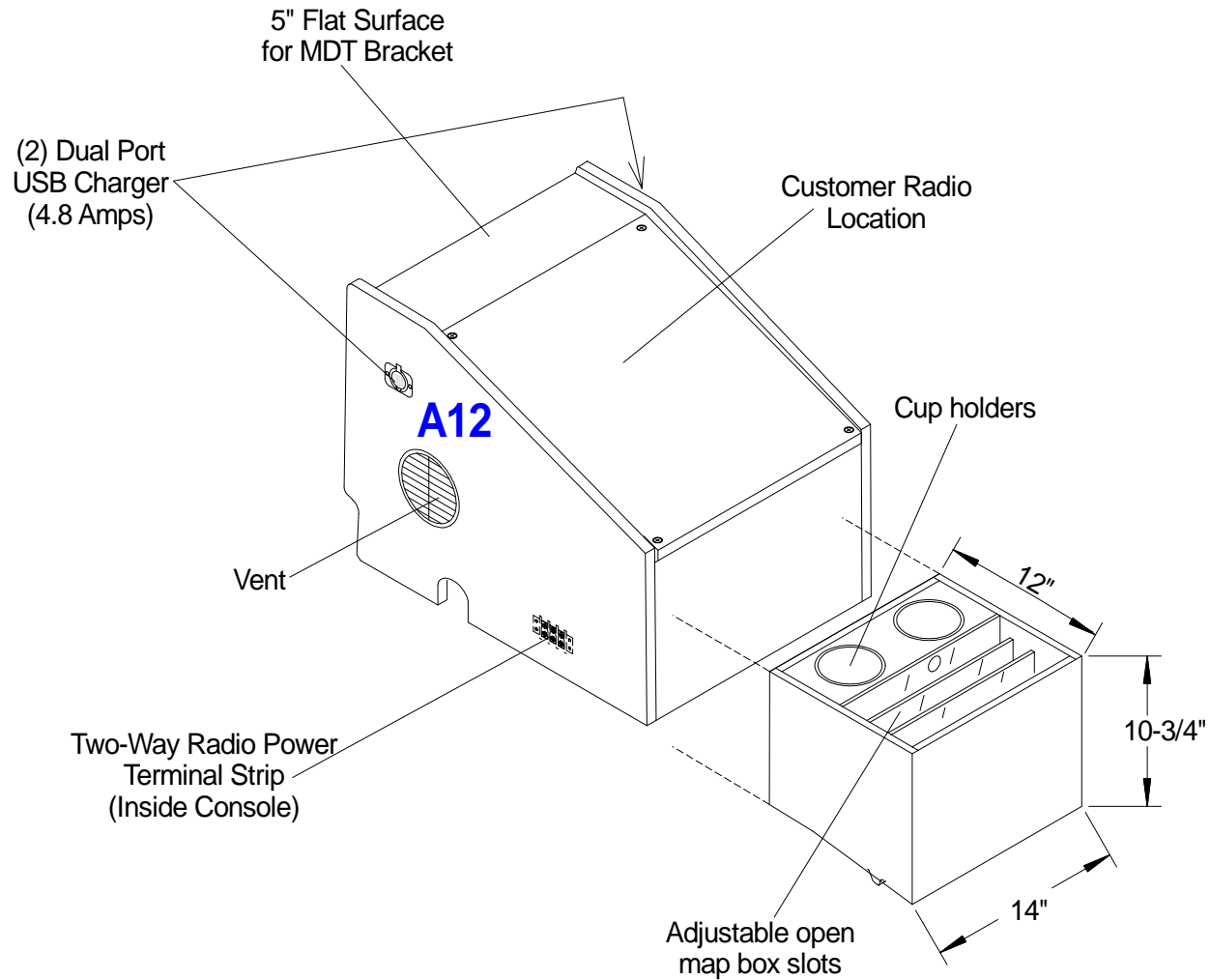

Note: All dimensions are approximate and subject to change.

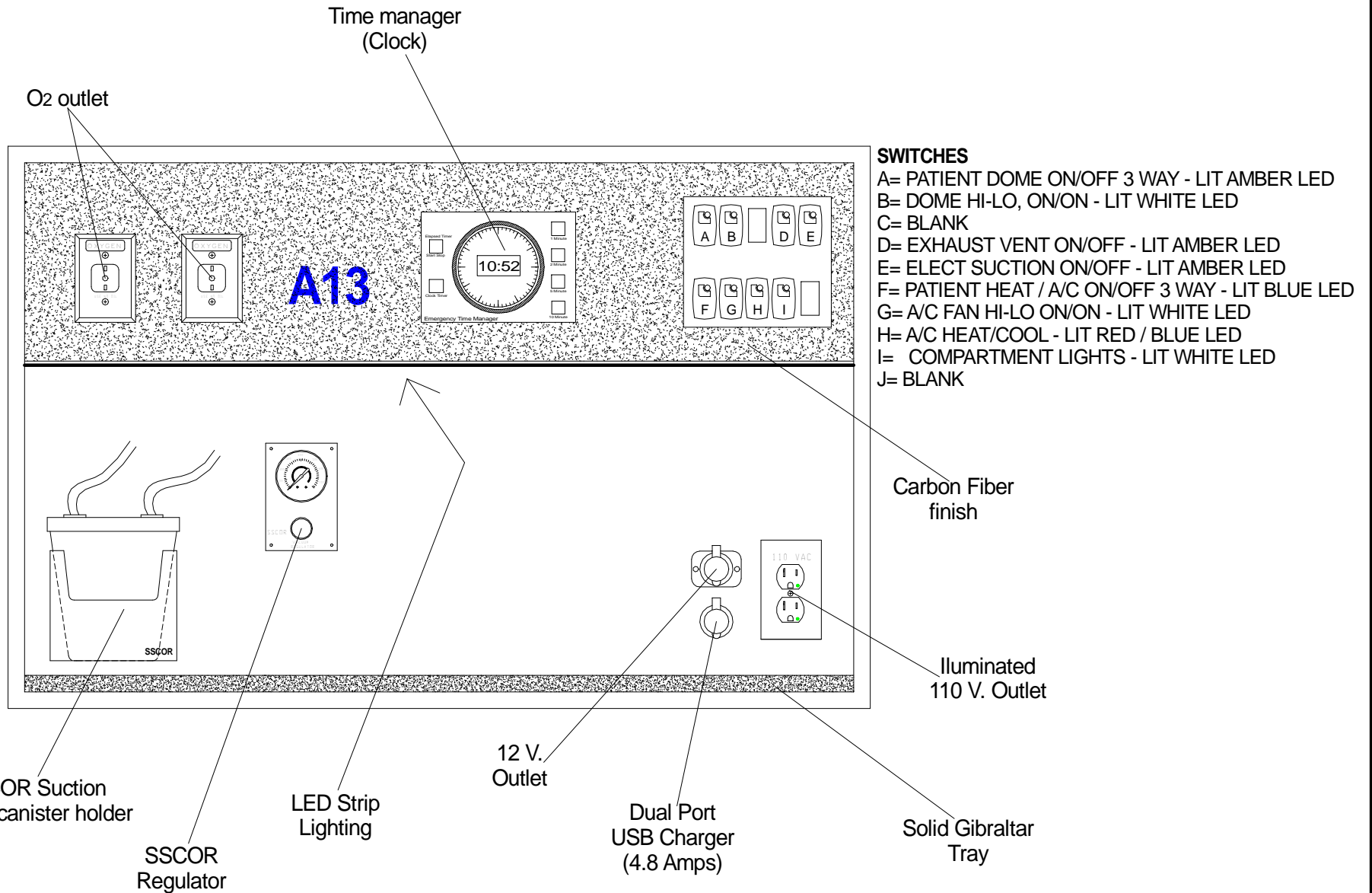

Note: All dimensions are approximate and subject to change.

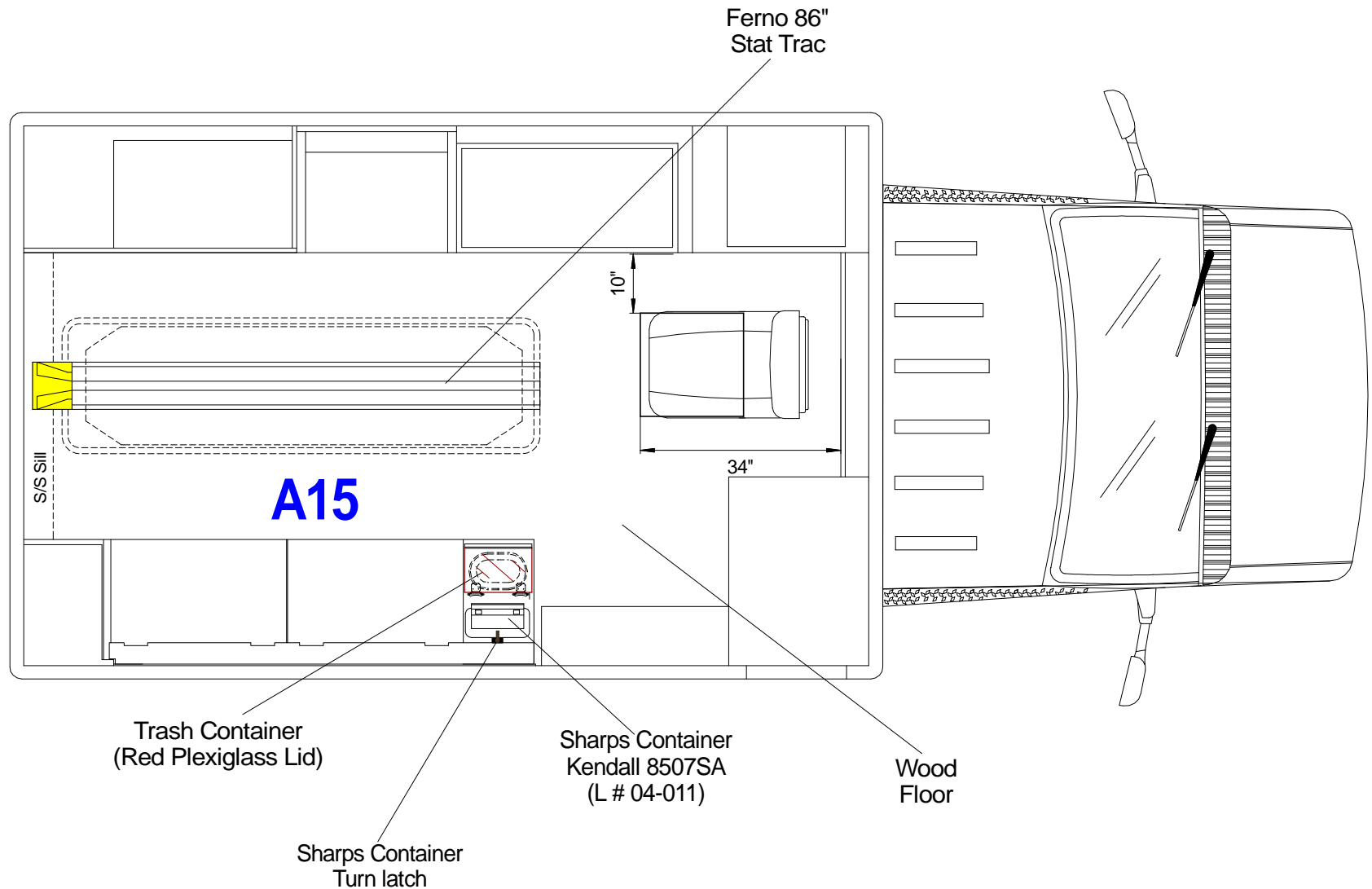

Note: All dimensions are approximate and subject to change.

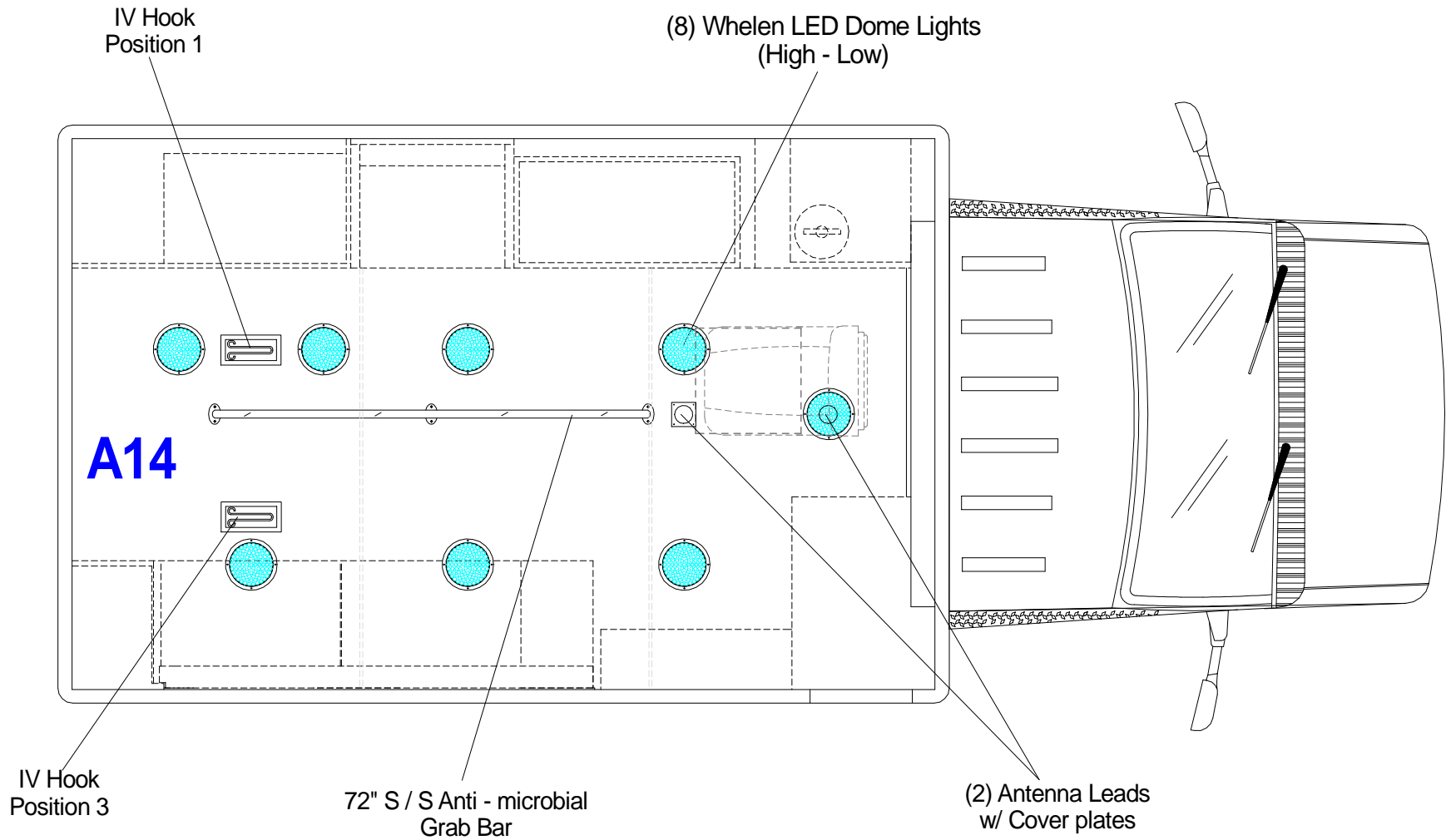

Note: All dimensions are approximate and subject to change.

Map lights  
Red / White LED

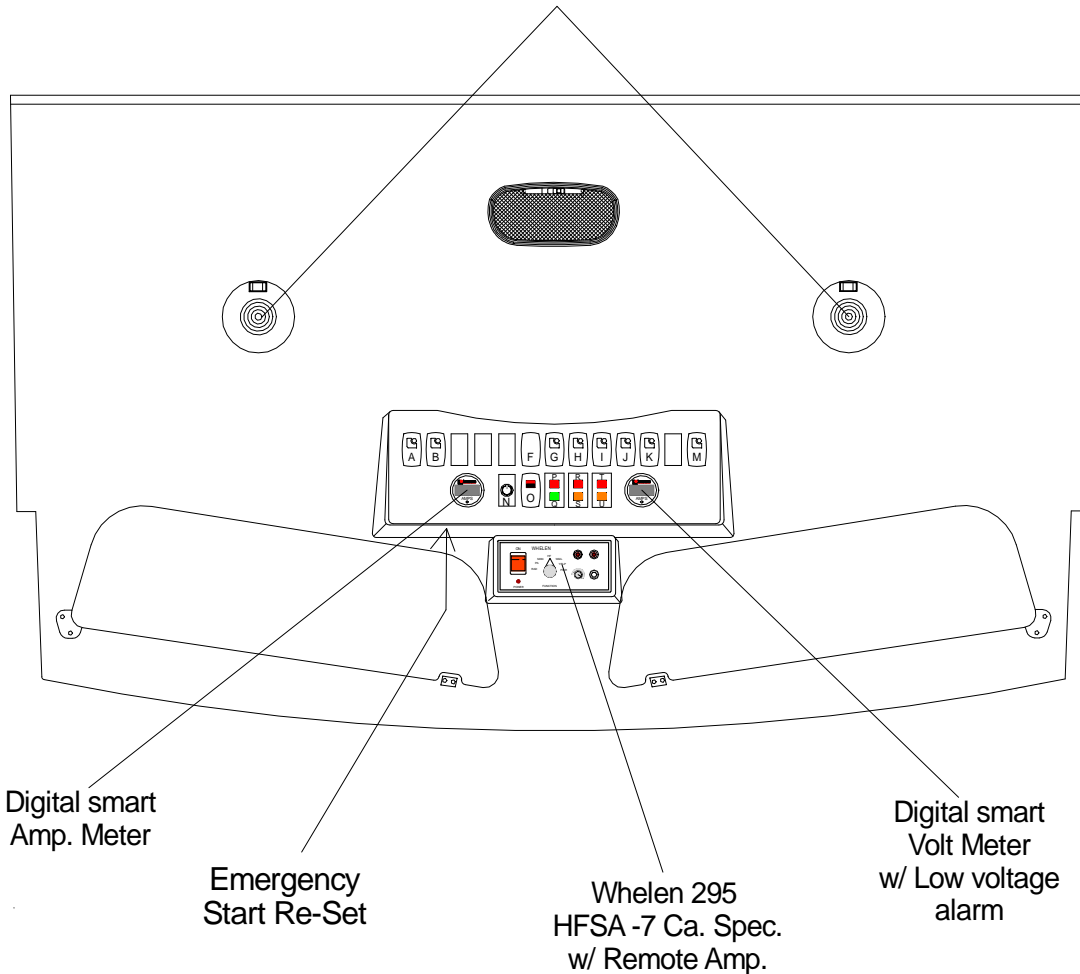

**SWITCHES**

- A. PRI- SEC- LIT RED/ AMBER LED  
(SIREN ACTIVATED PRIMARY ONLY)
- B. HEAD LIGHT FLASER -LIT CLEAR LED
- C. BLANK
- D. BLANK
- E. BLANK
- F. BACK UP ALARM-RESET TYPE-MOM. ON (NON LIT)
- G. LEFT SCENE WHITE LIT LED
- H. REAR SCENE WHITE LIT LED
- I. RIGHT SCENE WHITE LIT LED
- J. PATIENT DOME 3-WAY - LIT AMBER LED
- K. PATIENT HEAT A/C 3-WAY - LIT BLUE LED
- L. BLANK
- M. MOD. DISCONNECT - GREEN LIT LED
- N. DIMMER KNOB
- O. EMERGENCY START,ON-OFF GUARDED (NON LIT)

**PILOT LIGHTS**

- P. PILOT LIGHT - EMERGENCY START RED LED
- Q. PILOT LIGHT - MASTER ON GREEN LED
- R. PILOT LIGHT - DOOR OPEN RED LED
- S. PILOT LIGHT - COMP. OPEN AMBER LED
- T. PILOT LIGHT - PARKING BRAKE RED LED
- U. PILOT LIGHT - LOW VOLTAGE AMBER LED

Note: All dimensions are approximate and subject to change.